

Power Operational Amplifier

FEATURES

- ◆ LOW THERMAL RESISTANCE — 1.1°C/W
- ◆ CURRENT FOLDOVER PROTECTION
- ◆ EXCELLENT LINEARITY — Class A/B Output
- ◆ WIDE SUPPLY RANGE — ±10V to ±45V
- ◆ HIGH OUTPUT CURRENT — Up to ±15A Peak

APPLICATIONS

- ◆ MOTOR, VALVE AND ACTUATOR CONTROL
- ◆ MAGNETIC DEFLECTION CIRCUITS UP TO 10A
- ◆ POWER TRANSDUCERS UP TO 100kHz
- ◆ TEMPERATURE CONTROL UP TO 360V
- ◆ PROGRAMMABLE POWER SUPPLIES UP TO 90V
- ◆ AUDIO AMPLIFIERS UP TO 120W RMS

DESCRIPTION

The PA13 is a state of the art high voltage, very high output current operational amplifier designed to drive resistive, inductive and capacitive loads. For optimum linearity, especially at low levels, the output stage is biased for class A/B operation using a thermistor compensated base-emitter voltage multiplier circuit. The safe operating area (SOA) can be observed for all operating conditions by selection of user programmable current limiting resistors. For continuous operation under load, a heatsink of proper rating is recommended. The PA13 is not recommended for gains below -3 (inverting) or +4 (non-inverting).

This hybrid integrated circuit utilizes thick film (cermet) resistors, ceramic capacitors and semiconductor chips to maximize reliability, minimize size and give top performance. Ultrasonically bonded aluminum wires provide reliable interconnections at all operating temperatures. The 12-pin power SIP package is electrically isolated.

EQUIVALENT SCHEMATIC

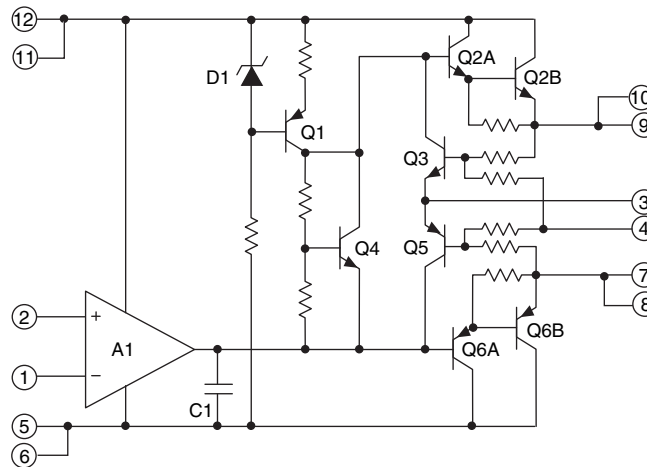

EXTERNAL CONNECTIONS

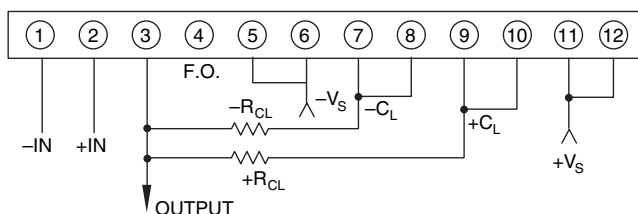

**12-pin SIP
PACKAGE
STYLE DP**

Formed leads available
See package style EE

1. CHARACTERISTICS AND SPECIFICATIONS

ABSOLUTE MAXIMUM RATINGS – PA13/PA13A

Parameter	Symbol	Min	Max	Units
SUPPLY VOLTAGE, +V _s to -V _s			100	V
OUTPUT CURRENT, within SOA			15	A
POWER DISSIPATION, internal			135	W
INPUT VOLTAGE, differential		-37	37	V
INPUT VOLTAGE, common mode		-V _s	V _s	V
TEMPERATURE, pin solder, 10s max.			260	°C
TEMPERATURE, junction (Note 3)			175	°C
TEMPERATURE RANGE, storage		-55	125	°C
OPERATING TEMPERATURE RANGE, case		-40	85	°C

CAUTION The exposed substrate contains beryllia (BeO). Do not crush, machine, or subject to temperatures in excess of 850°C to avoid generating toxic fumes.

SPECIFICATIONS

Parameter	Test Conditions ^{2,5}	PA13			PA13A			Units
		Min	Typ	Max	Min	Typ	Max	
INPUT								
OFFSET VOLTAGE, initial			±2	±6		±1	±4	mV
OFFSET VOLTAGE vs. temp	Full temp range		±10	±65		*	±40	µV/°C
OFFSET VOLTAGE vs. supply			±30	±200		*	*	µV/V
OFFSET VOLTAGE vs. power			±20			*		µV/W
BIAS CURRENT, initial			±12	±30		±10	±20	nA
BIAS CURRENT, vs. temp	Full temp range		±50	±500		*	*	pA/°C
BIAS CURRENT, vs. supply			±10			*		pA/V
OFFSET CURRENT, initial			±12	±30		±5	±10	nA
OFFSET CURRENT, vs. temp	Full temp range		±50			*		pA/°C
INPUT IMPEDANCE, DC			200			*		MΩ
INPUT CAPACITANCE			3			*		pF
COMMON MODE VOLTAGE RANGE (Note 4)	Full temp range	±V _s - 5	±V _s - 3		*	*		V
COMMON MODE REJECTION, DC	Full temp range, V _{CM} = ±V _s - 6V	74	100		*	*		dB
GAIN								
OPEN LOOP GAIN @ 10Hz	1KΩ load		110			*		dB
OPEN LOOP GAIN @ 10Hz	Full temp range, 8Ω load	96	108		*	*		dB
GAIN BANDWIDTH PRODUCT @ 1MHz	8Ω load		4			*		MHz
POWER BANDWIDTH	8Ω load	13	20		*	*		kHz
PHASE MARGIN, A _v = +4	Full temp range, 8Ω load		20			*		°

Parameter	Test Conditions ^{2,5}	PA13			PA13A			Units
		Min	Typ	Max	Min	Typ	Max	
OUTPUT								
VOLTAGE SWING (Note 4)	PA13 = 10A, PA13A = 15A	$\pm V_s - 6$			*			V
VOLTAGE SWING (Note 4)	$I_o = 5A$	$\pm V_s - 5$			*			V
VOLTAGE SWING (Note 4)	Full temp range, $I_o = 80mA$	$\pm V_s - 5$			*			V
CURRENT, peak		10			15			A
SETTLING TIME to 0.1%	2V step		2			*		μS
SLEW RATE		2.5	4		*	*		V/ μS
CAPACITIVE LOAD	Full temp range, $A_v = 4$			1.5			*	nF
CAPACITIVE LOAD	Full temp range, $A_v > 10$			SOA			*	
POWER SUPPLY								
VOLTAGE	Full temp range	± 10	± 40	± 45	*	*	*	V
CURRENT, quiescent			25	50		*	*	mA
THERMAL								
RESISTANCE, AC, junction to case (Note 5)	$T_c = -55$ to $+125^\circ C$, F > 60Hz		0.6	0.7		*	*	$^\circ C/W$
RESISTANCE, DC, junction to case	$T_c = -55$ to $+125^\circ C$		0.9	1.1		*	*	$^\circ C/W$
RESISTANCE, DC, junction to air	$T_c = -55$ to $+125^\circ C$		30			*		$^\circ C/W$
TEMPERATURE RANGE, case	Meets full range specification	-25		+85	*		*	$^\circ C$

- NOTES: 1. (All Min/Max characteristics and specifications are guaranteed over the Specified Operating Conditions. Typical performance characteristics and specifications are derived from measurements taken at typical supply voltages and $T_c = 25^\circ C$).
2. Long term operation at the maximum junction temperature will result in reduced product life. Derate power dissipation to achieve high MTTF.
- * The specification of PA13A is identical to the specification for PA13 in the applicable column to the left
3. The power supply voltage for all tests is ± 40 , unless otherwise noted as a test condition.
4. $+V_s$ and $-V_s$ denote the positive and negative supply rail respectively. Total V_s is measured from $+V_s$ to $-V_s$.
5. Rating applies if the output current alternates between both output transistors at a rate faster than 60Hz.
6. Full temperature range specifications are guaranteed but not 100% tested.

POWER RATING

Not all vendors use the same method to rate the power handling capability of a Power Op Amp. Apex Microtechnology rates the internal dissipation, which is consistent with rating methods used by transistor manufacturers and gives conservative results. Rating delivered power is highly application dependent and therefore can be misleading. For example, the 135W internal dissipation rating of the PA13 could be expressed as an output rating of 260W for audio (sine wave) or as 440W if using a single ended DC load. Please note that all vendors rate maximum power using an infinite heatsink.

THERMAL STABILITY

Apex Microtechnology has eliminated the tendency of class A/B output stages toward thermal runaway and thus has vastly increased amplifier reliability. This feature, not found in most other Power Op Amps, was pioneered by Apex Microtechnology in 1981 using thermistors which assure a negative temperature coefficient in the quiescent current. The reliability benefits of this added circuitry far outweigh the slight increase in component count.

TYPICAL APPLICATION

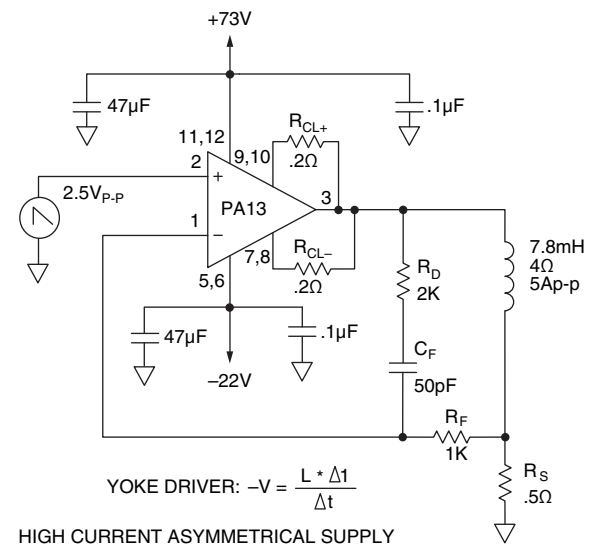

TYPICAL PERFORMANCE GRAPHS

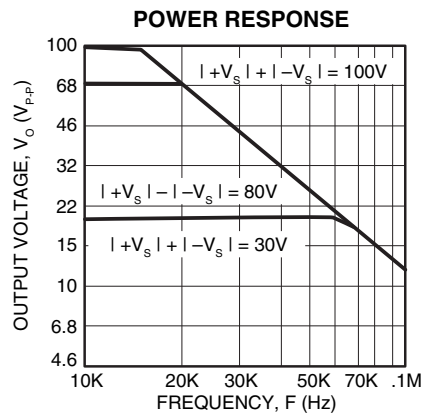
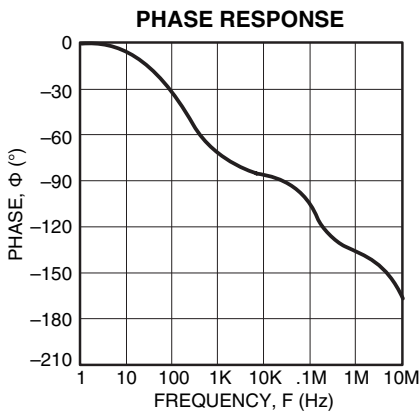
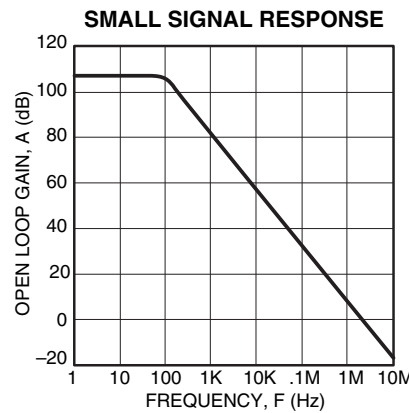
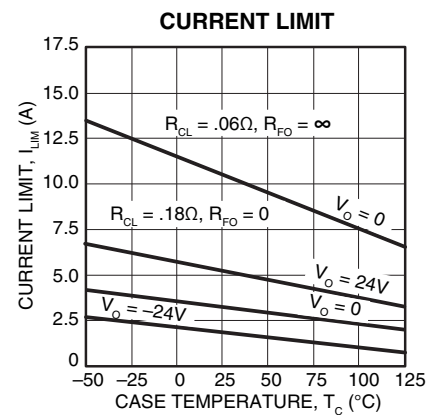
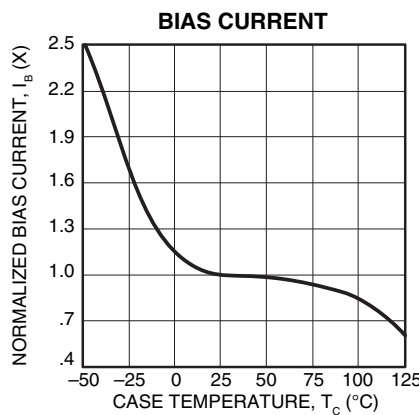
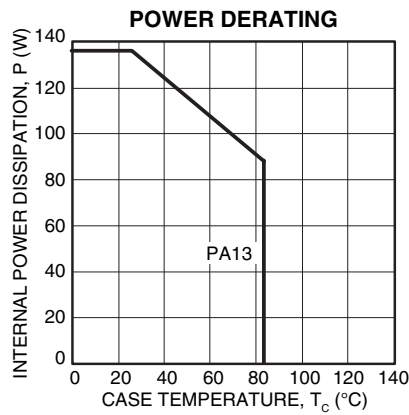

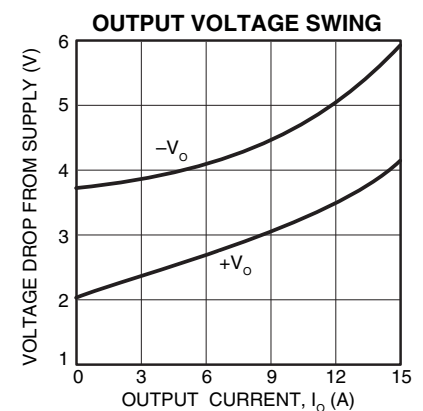
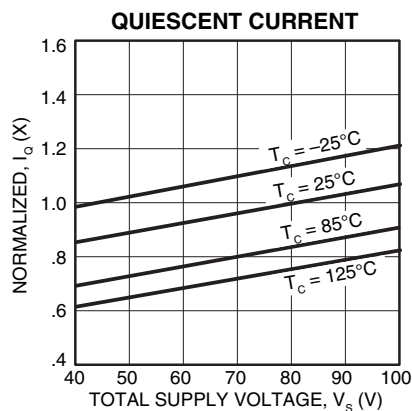
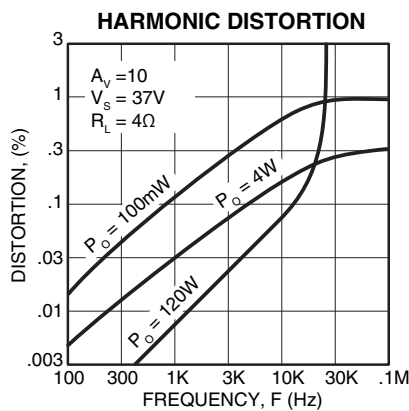
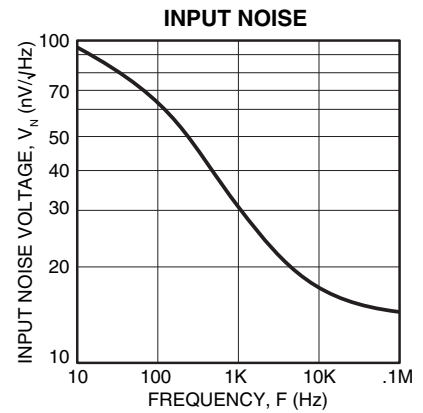
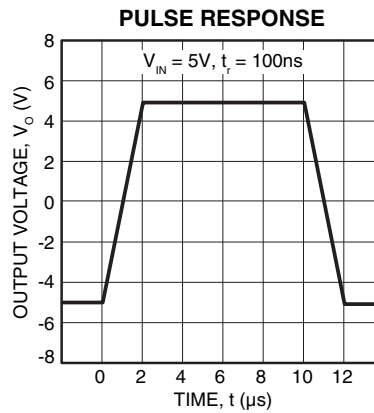
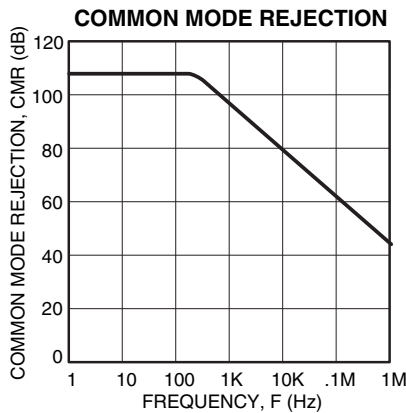

GENERAL

Please read Application Note 1 "General Operating Considerations" which covers stability, supplies, heat sinking, mounting, current limit, SOA interpretation, and specification interpretation. Visit www.apexanalog.com for design tools that help automate tasks such as calculations for stability, internal power dissipation, current limit; heat sink selection; Apex Microtechnology's complete Application Notes library; Technical Seminar Workbook; and Evaluation Kits.

SAFE OPERATING AREA (SOA)

The output stage of most power amplifiers has three distinct limitations:

1. The current handling capability of the transistor geometry and the wire bonds.
2. The second breakdown effect which occurs whenever the simultaneous collector current and collector-emitter voltage exceeds specified limits.
3. The junction temperature of the output transistors.

The SOA curves combine the effect of all limits for this Power Op Amp. For a given application, the direction and magnitude of the output current should be calculated or measured and checked against the SOA curves. This is simple for resistive loads but more complex for reactive and EMF generating loads. However, the following guidelines may save extensive analytical efforts.

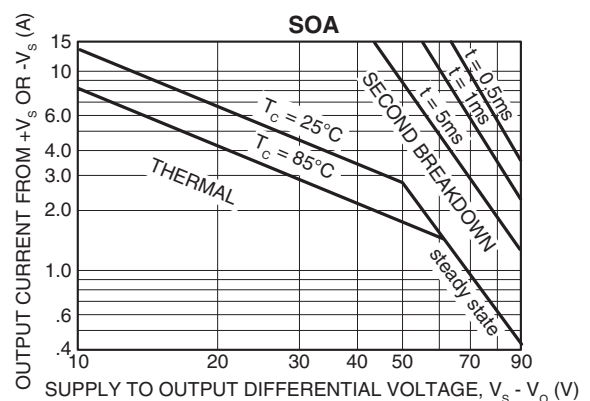

1. Capacitive and dynamic* inductive loads up to the following maximum are safe with the current limits set as specified.

$\pm V_s$	CAPACITIVE LOAD		INDUCTIVE LOAD	
	$I_{LIM} = 5A$	$I_{LIM} = 10A$	$I_{LIM} = 5A$	$I_{LIM} = 10A$
50V	200 μ F	125 μ F	5mH	2.0mH
40V	500 μ F	350 μ F	15mH	3.0mH
35V	2.0mF	850 μ F	50mH	5.0mH
30V	7.0mF	2.5mF	150mH	10mH
25V	25mF	10mF	500mH	20mH
20V	60mF	20mF	1,000mH	30mH
15V	150mF	60mF	2,500mH	50mH

*If the inductive load is driven near steady state conditions, allowing the output voltage to drop more than 12.5V below the supply rail with $I_{LIM} = 10A$ or 27V below the supply rail with $I_{LIM} = 5A$ while the amplifier is current limiting, the inductor must be capacitively coupled or the current limit must be lowered to meet SOA criteria.

2. The amplifier can handle any EMF generating or reactive load and short circuits to the supply rail or common if the current limits are set as follows at $T_C = 25^\circ C$:

$\pm V_s$	SHORT TO $\pm V_s$	SHORT TO
	C, L, OR EMF LOAD	COMMON
45V	.43A	3.0A
40V	.65A	3.4A
35V	1.0A	3.9A
30V	1.7A	4.5A
25V	2.7A	5.4A
20V	3.4A	6.7A
15V	4.5A	9.0A

These simplified limits may be exceeded with further analysis using the operating conditions for a specific application.

CURRENT LIMITING

Refer to Application Note 9, "Current Limiting", for details of both fixed and foldover current limit operation. Visit the Apex Microtechnology web site at www.apexanalog.com for a copy of Power_design.exe which plots current limits vs. steady state SOA. Beware that current limit should be thought of as a $\pm 20\%$ function initially and varies about 2:1 over the range of $-55^\circ C$ to $125^\circ C$.

For fixed current limit, leave pin 4 open and use equations 1 and 2.

$$R_{CL} = \frac{0.65}{I_{CL}} \quad (1)$$

$$I_{CL} = \frac{0.65}{R_{CL}} \quad (2)$$

Where:

I_{CL} is the current limit in amperes.

R_{CL} is the current limit resistor in ohms.

For certain applications, foldover current limit adds a slope to the current limit which allows more power to be delivered to the load without violating the SOA. For maximum foldover slope, ground pin 4 and use equations 3 and 4.

$$I_{CL} = \frac{0.65 + (V_o * 0.014)}{R_{CL}} \quad (3)$$

$$R_{CL} = \frac{0.65 + (V_o * 0.014)}{I_{CL}} \quad (4)$$

Where:

V_o is the output voltage in volts.

Most designers start with either equation 1 to set R_{CL} for the desired current at 0v out, or with equation 4 to set R_{CL} at the maximum output voltage. Equation 3 should then be used to plot the resulting foldover limits on the SOA graph. If equation 3 results in a negative current limit, foldover slope must be reduced. This can happen when the output voltage is the opposite polarity of the supply conducting the current.

In applications where a reduced foldover slope is desired, this can be achieved by adding a resistor (R_{FO}) between pin 4 and ground. Use equations 4 and 5 with this new resistor in the circuit.

$$I_{CL} = \frac{0.65 + \frac{V_o * 0.14}{10.14 + R_{FO}}}{R_{CL}} \quad (5)$$

$$R_{CL} = \frac{0.65 + \frac{V_o * 0.14}{10.14 + R_{FO}}}{I_{CL}} \quad (6)$$

Where:

R_{FO} is in K ohms.

NEED TECHNICAL HELP? CONTACT APEX SUPPORT!

For all Apex Microtechnology product questions and inquiries, call toll free 800-546-2739 in North America.

For inquiries via email, please contact apex.support@apexanalog.com.

International customers can also request support by contacting their local Apex Microtechnology Sales Representative.

To find the one nearest to you, go to www.apexanalog.com

IMPORTANT NOTICE

Apex Microtechnology, Inc. has made every effort to insure the accuracy of the content contained in this document. However, the information is subject to change without notice and is provided "AS IS" without warranty of any kind (expressed or implied). Apex Microtechnology reserves the right to make changes without further notice to any specifications or products mentioned herein to improve reliability. This document is the property of Apex Microtechnology and by furnishing this information, Apex Microtechnology grants no license, expressed or implied under any patents, mask work rights, copyrights, trademarks, trade secrets or other intellectual property rights. Apex Microtechnology owns the copyrights associated with the information contained herein and gives consent for copies to be made of the information only for use within your organization with respect to Apex Microtechnology integrated circuits or other products of Apex Microtechnology. This consent does not extend to other copying such as copying for general distribution, advertising or promotional purposes, or for creating any work for resale.

APEX MICROTECHNOLOGY PRODUCTS ARE NOT DESIGNED, AUTHORIZED OR WARRANTED TO BE SUITABLE FOR USE IN PRODUCTS USED FOR LIFE SUPPORT, AUTOMOTIVE SAFETY, SECURITY DEVICES, OR OTHER CRITICAL APPLICATIONS. PRODUCTS IN SUCH APPLICATIONS ARE UNDERSTOOD TO BE FULLY AT THE CUSTOMER OR THE CUSTOMER'S RISK.

Apex Microtechnology, Apex and Apex Precision Power are trademarks of Apex Microtechnology, Inc. All other corporate names noted herein may be trademarks of their respective holders.