

DESCRIPTION: COAXIAL/SIGNAL VERTICAL BOARD MOUNT

FACE VIEW OF RECEPTACLE IS SHOWN

PART NUMBER KEY

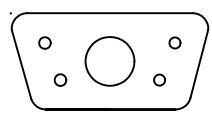

5W1

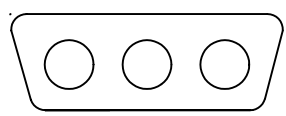

3W3

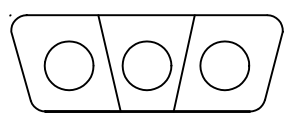

3W3K

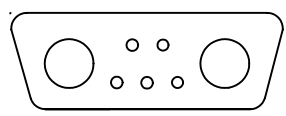

7W2

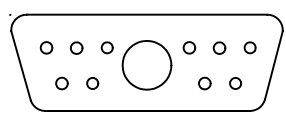

11W1

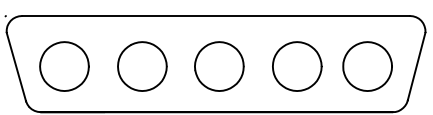

5W5

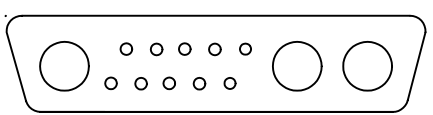

13W3

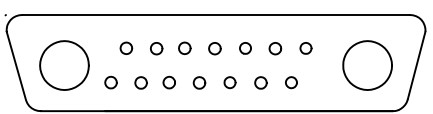

17W2

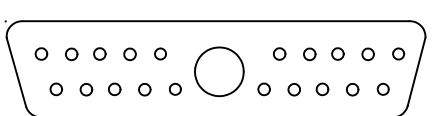

21W1

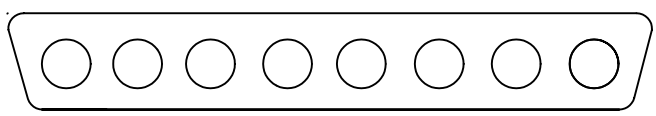

8W8

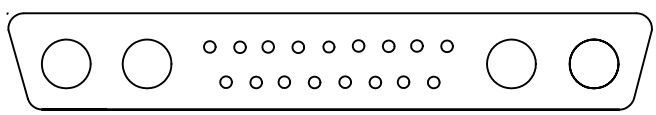

21WA4

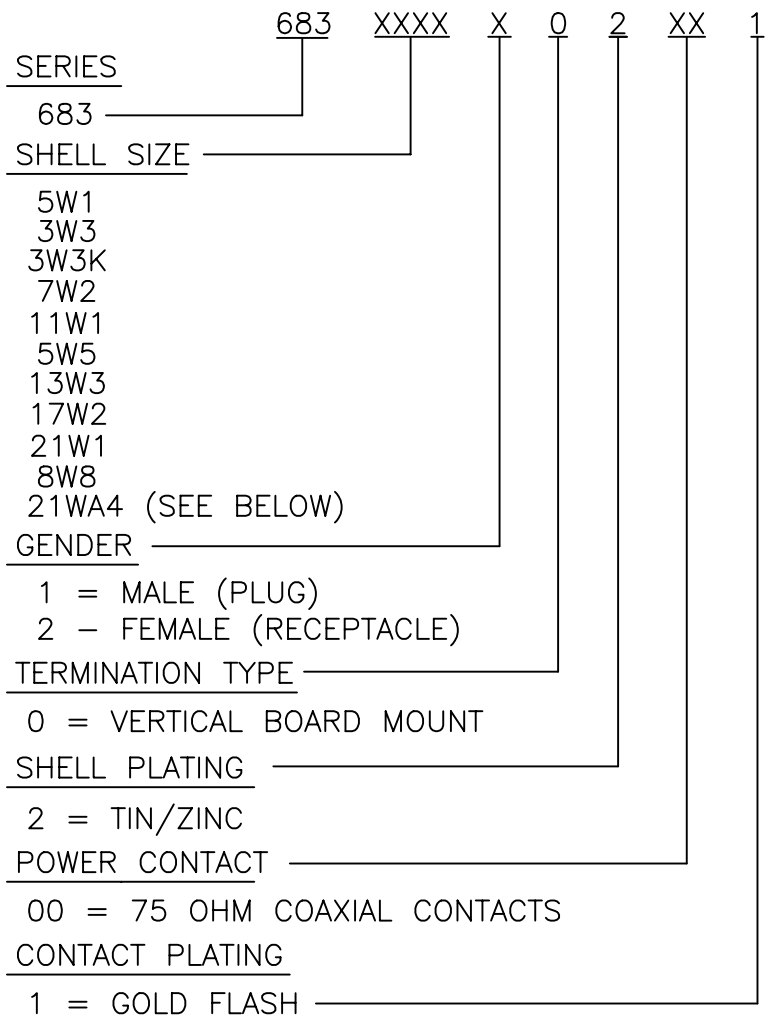

68321WA4 PART NUMBERS = 68321WA4P001 (MALE)
68321WA4S001 (FEMALE)

	THESE DRAWINGS AND SPECIFICATIONS ARE THE PROPERTY OF NorComp AND SHALL NOT BE REPRODUCED, COPIED OR USED AS THE BASIS FOR THE MANUFACTURE OR SALE OF APPARATUS WITHOUT WRITTEN PERMISSION.		DRAWN: PAM JENKINS	DATE: 6-5-02
			CHECKED:	DATE:
<h1>NorComp</h1>		SCALE:	SHEET 1 OF 1	REV 2
		DWG NO. 683 SERIES CONNECTORS		

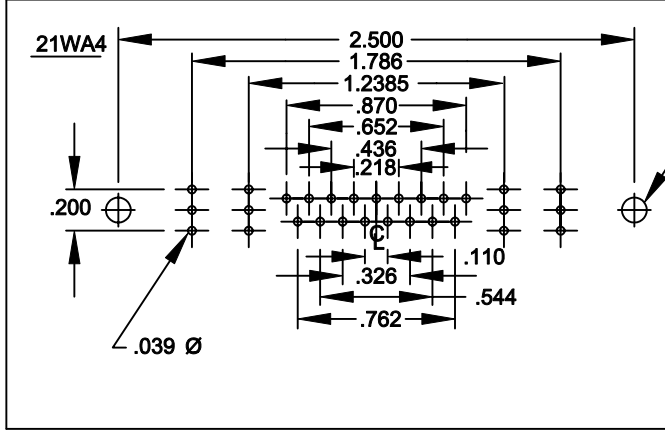
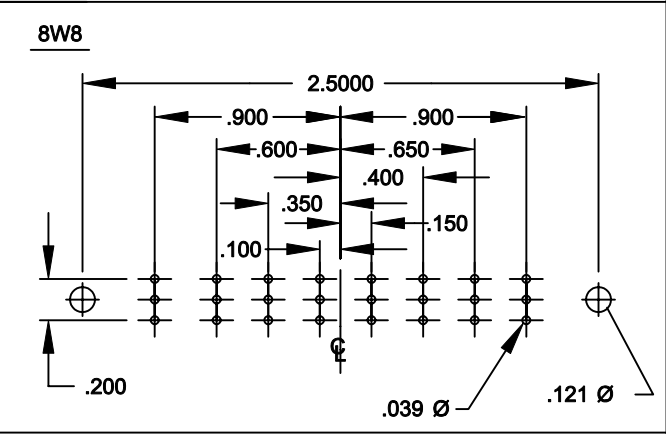
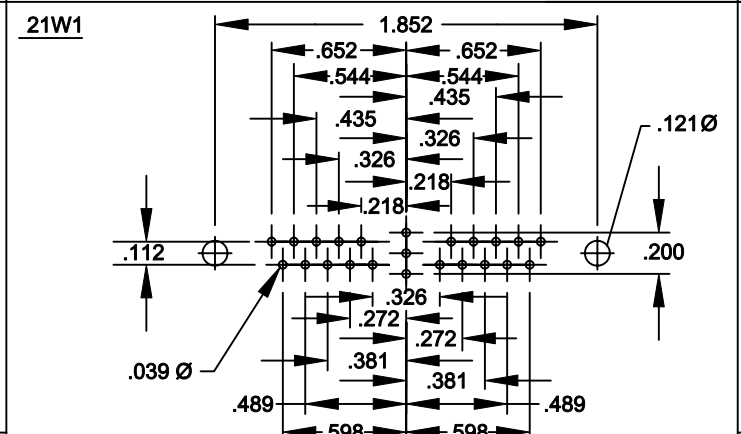
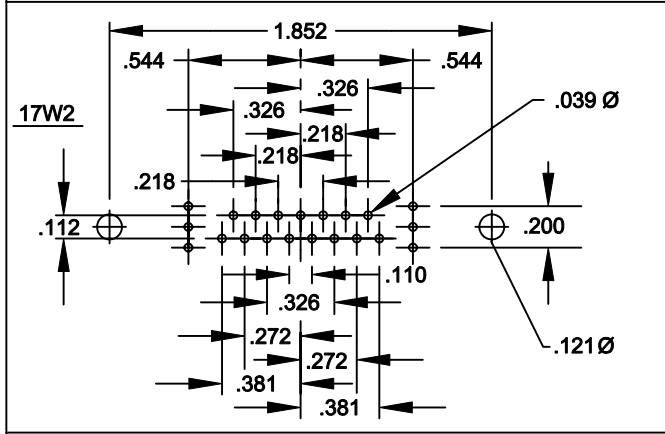
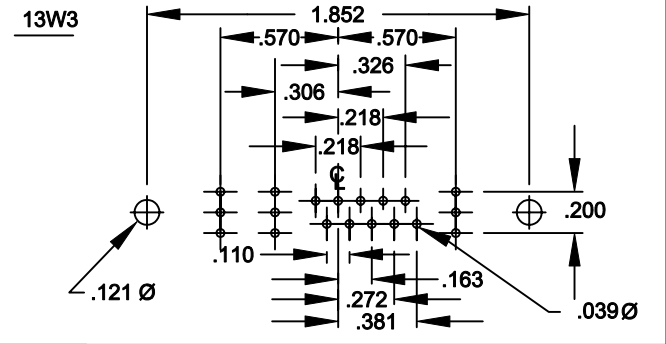
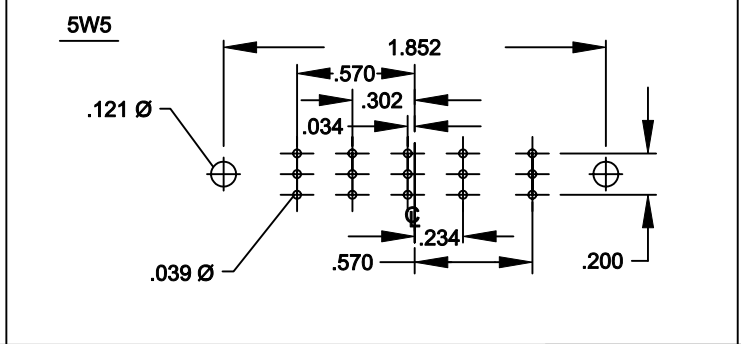
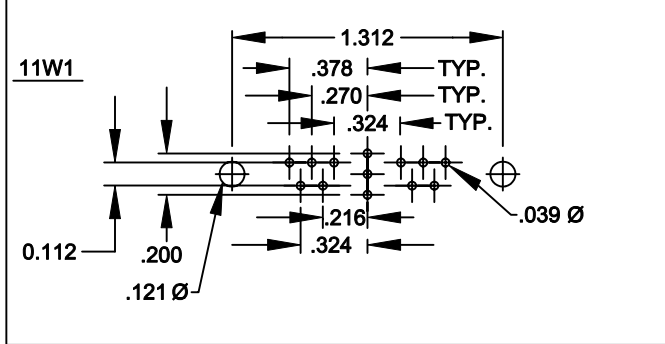
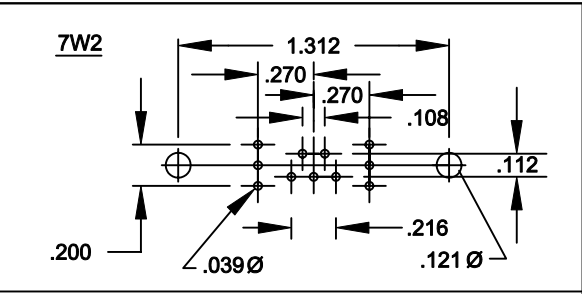
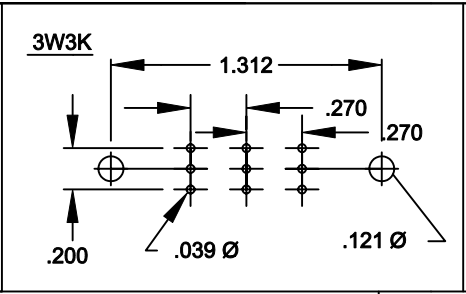
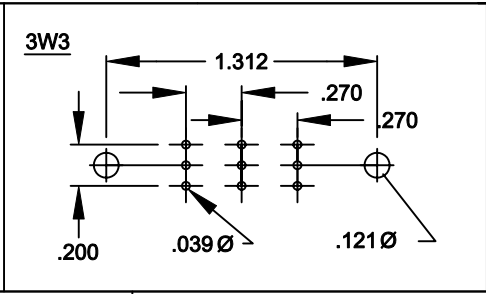
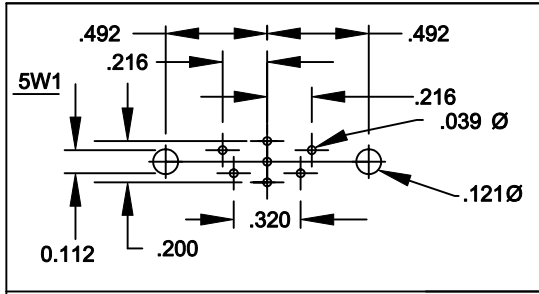

	THESE DRAWINGS AND SPECIFICATIONS ARE THE PROPERTY OF NorComp AND SHALL NOT BE REPRODUCED, COPIED OR USED AS THE BASIS FOR THE MANUFACTURE OR SALE OF APPARATUS WITHOUT WRITTEN PERMISSION.		DRAWN: PAM JENKINS	DATE: 3-3-03
			CHECKED:	DATE:
<h1>NorComp</h1>		SCALE:	SHEET 1 OF 1	REV 2
		DWG NO. 683 Series Male Footprints		

DESCRIPTION: SIGNAL/COAXIAL VERTICAL BOARD MOUNT

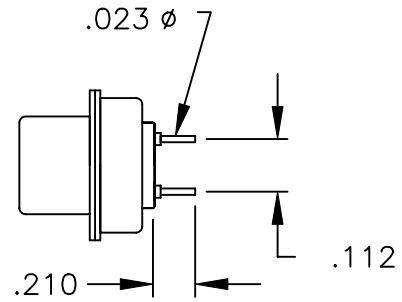

SIGNAL CONTACTS

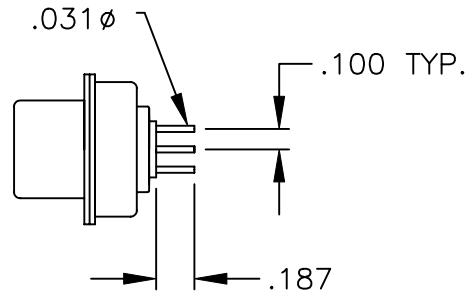

75 OHM COAXIAL CONTACT

NOTE: SIGNAL AND COAXIAL CONTACTS COME PRE-LOADED INTO INSULATOR.

	THESE DRAWINGS AND SPECIFICATIONS ARE THE PROPERTY OF NorComp AND SHALL NOT BE REPRODUCED, COPIED OR USED AS THE BASIS FOR THE MANUFACTURE OR SALE OF APPARATUS WITHOUT WRITTEN PERMISSION.		DRAWN: PAM JENKINS	DATE: 6-5-02
			CHECKED:	DATE:
<h1>NorComp</h1>		SCALE:	SHEET 1 OF 1	REV 2
		DWG NO. 683 XXXX X 0 2 XX 1		

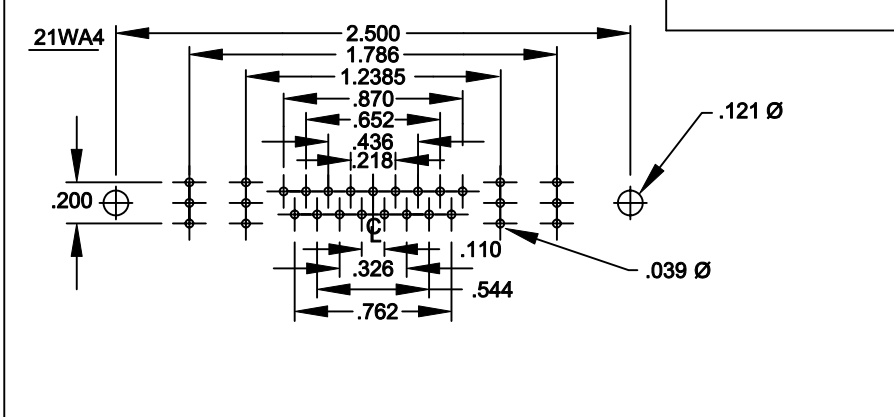
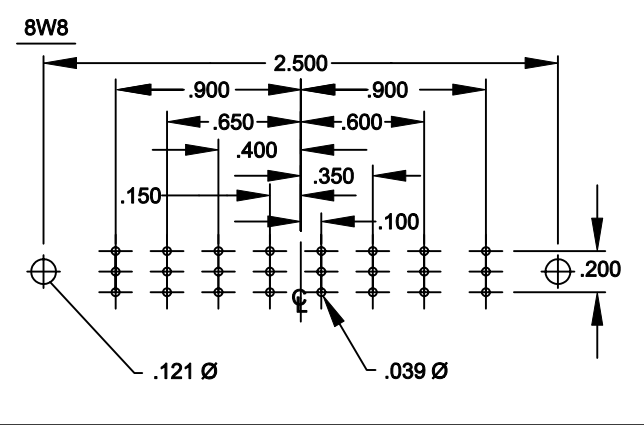
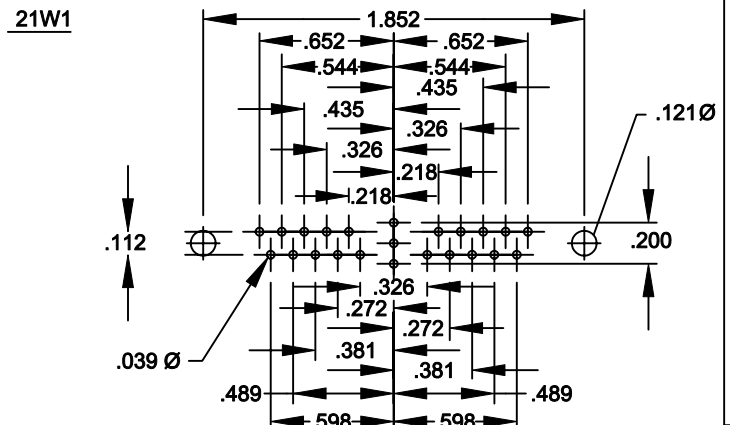
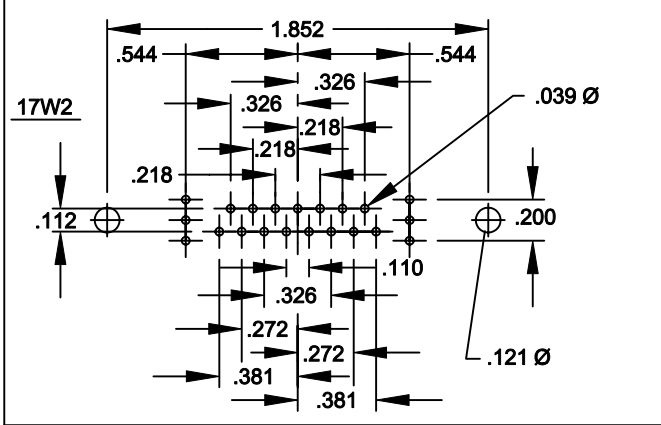
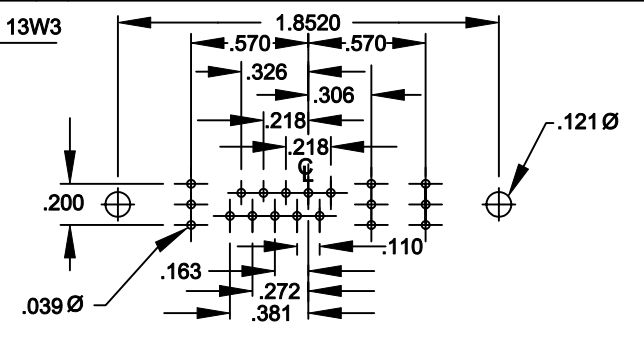
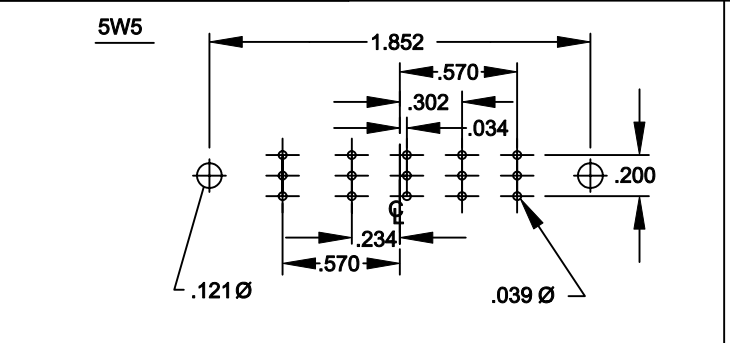
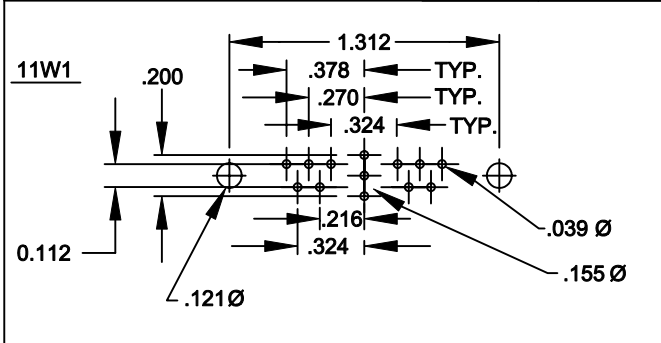
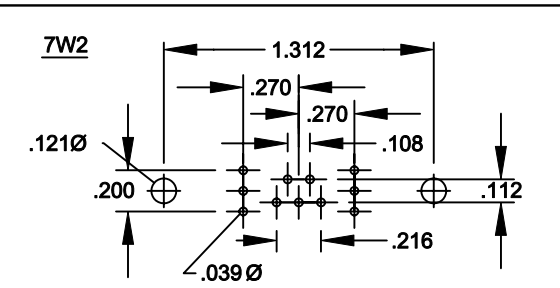
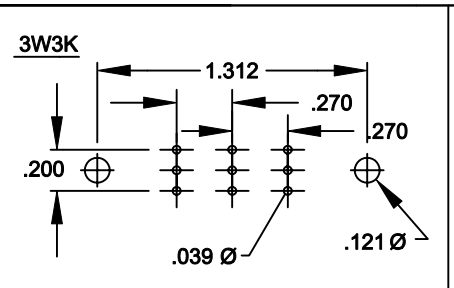
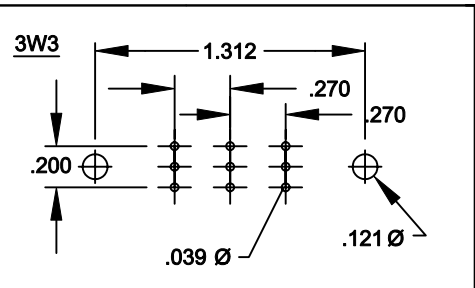
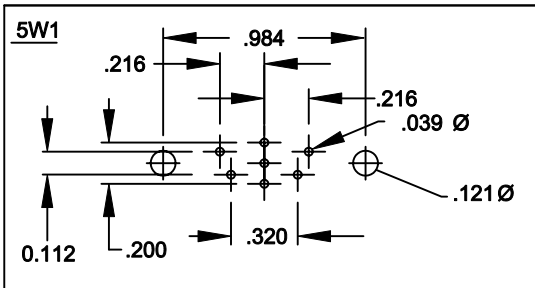

	THESE DRAWINGS AND SPECIFICATIONS ARE THE PROPERTY OF NorComp AND SHALL NOT BE REPRODUCED, COPIED OR USED AS THE BASIS FOR THE MANUFACTURE OR SALE OF APPARATUS WITHOUT WRITTEN PERMISSION.		DRAWN: PAM JENKINS	DATE: 3-3-03
			CHECKED:	DATE:
<h1>NorComp</h1>		SCALE:	SHEET 1 OF 1	REV 2
		DWG NO. 683 Series Female Footprints		